

VIERKANTE BALENKLEM (COMPACTE MACHINES)

KLEMMEN

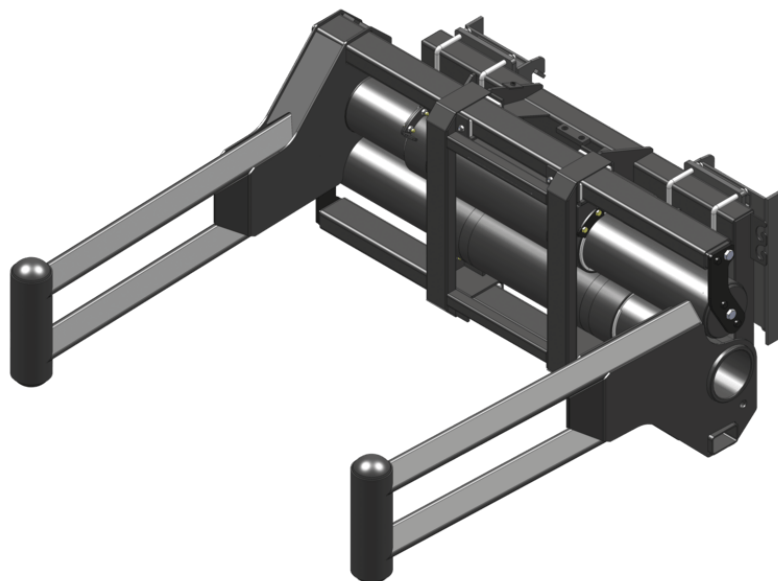

GEHL®

Voordelen voor de klant

- Buisvormige structuur - geen enkel risico op schade aan de folie bij de verplaatsing van gewikkelde balen.
- Grote opening van de klem om grote balen of verschillende gangbare balen te verhandelen.
- Hogere bescherming van de componenten.
- Multi inzetbaar: ontworpen voor rechthoekige gewikkelde balen, kan ook worden gebruikt voor standaard rechthoekige balen of ronde balen.







Technische kenmerken

- Robuuste kader en componenten voor intensieve toepassingen.
- Telescoop kinematic - zachte bewegingen en sterke knijpcapaciteit.
- Algemeen gebruik van téflon®.
- Beperkt onderhoud.
- Standaard drukbegrenzer.

MANITOU GROUP ATTACHMENTS

Hoedanigheid		CLBSW 2000 / 1000	
Capaciteit (kg)		1000	
Weight			
Gewicht (kg)		477	
Gewicht en afmetingen			
Totale hoogte (mm)	h17	679	
Lengte armen (mm)		1811	
Operationele parameters			
Machine-apparatuur			
Opening minimum (mm)		740	
Opening maximum (mm)		2090	

Machine compatibiliteit		CLBSW 2000 / 1000	
All-Tach®		NS1502694	
4 point Carriage		NS1502693	
Euro Carriage		NS1502692	
AL650		X	
AL750		X	
MLA 6-65 H-Z		X	
MLA 7-75 H-Z OLD		X	

TABEL VAN SYMBOLEN					
	Geen aanleg vereist		Hydraulische leiding		Hydraulische retour naar tank
	Elektrische voorbereiding		Voorpositionering platform		Voorpositionering bandenlichter, cilinderlichter



GEHL®

Siège Social
P.O. Box 179 - One Gehl Way - West Bend, WI, USA 53095
Tel: (262) 334-9461 - Fax: (262) 338-7517
www.gehl.com



This brochure describes versions and configuration options for Gehl products which may be fitted with different equipment. The equipment described in this brochure may be standard, optional or not available depending on version. Gehl reserves the right to change the specifications shown and described at any time and without prior warning. The manufacturer is not liable for the specifications given. For more information, contact your Gehl dealer. Non-contractual document. Product descriptions may differ from actual products. List of specifications is not comprehensive. The logos and visual identity of the company are the property of Gehl and may not be used without authorization. All rights reserved. The photos and diagrams contained in this brochure are provided for information only.

MANITOU EQUIPMENT AMERICAS, LLC - Limited company with board of directors - Share capital: 39,668,399 euros - 857 802 508 RCS West Bend